

# COMBIVERT



**GB** INSTRUCTION MANUAL

Control Circuit from V3.2



**GB - 3.....GB**  
**- 40**

This Instruction Manual describes the control circuit of the KEB COMBIVERT F5 - Series. It is only valid together with the Instruction Manuals Part 1 and Part 2. Both Instruction Manuals must be made available to the user. Prior to performing any work on the unit the user must familiarize himself with the unit. This includes especially the knowledge and observance of the safety and warning directions of Part 1. The pictographs used in this instruction manual have following meaning:



**Danger  
Warning  
Caution**



**Attention,  
observe at  
all costs**



**Information  
Help  
Tip**

|            |   |           |
|------------|---|-----------|
| <b>1.</b>  | <b>General .....</b>                        | <b>4</b>  |
| <b>2.</b>  | <b>Installation and Connection .....</b>    | <b>5</b>  |
| <b>2.1</b> | <b>Summary .....</b>                        | <b>5</b>  |
| 2.1.1      | Housing Size D - E .....                    | 5         |
| 2.1.2      | Housing Size >= G.....                      | 5         |
| <b>2.2</b> | <b>Control Circuit MULTI.....</b>           | <b>6</b>  |
| 2.2.1      | Assignment of Terminal Strip X2A .....      | 6         |
| 2.2.2      | Connection of the control circuit .....     | 7         |
| 2.2.3      | Digital Inputs .....                        | 7         |
| 2.2.4      | Analog Inputs.....                          | 7         |
| 2.2.5      | Voltage Input / External Power Supply ..... | 8         |
| 2.2.6      | Digital Outputs .....                       | 8         |
| 2.2.7      | Relay Outputs.....                          | 8         |
| 2.2.8      | Analog Outputs.....                         | 8         |
| 2.2.9      | Voltage Output.....                         | 8         |
| <b>2.3</b> | <b>Operator.....</b>                        | <b>9</b>  |
| <b>3.</b>  | <b>Operation of the Unit.....</b>           | <b>10</b> |
| <b>3.1</b> | <b>Keyboard .....</b>                       | <b>10</b> |
| <b>3.2</b> | <b>Parameter description.....</b>           | <b>11</b> |
| 3.2.1      | Password Input.....                         | 12        |
| 3.2.2      | Operating Display .....                     | 12        |
| 3.2.3      | Basic Adjustment of the Drive.....          | 14        |
| 3.2.4      | Special Adjustments .....                   | 17        |
| <b>3.3</b> | <b>Factory Settings.....</b>                | <b>23</b> |
| <b>3.4</b> | <b>The drive mode .....</b>                 | <b>24</b> |
| 3.4.1      | Start/stop drive.....                       | 24        |
| 3.4.2      | Changing the direction of rotation.....     | 24        |
| 3.4.3      | Presetting the setpoint.....                | 24        |
| 3.4.4      | Leaving the drive mode .....                | 24        |
| <b>4.</b>  | <b>Error Assistance .....</b>               | <b>25</b> |
| <b>5.</b>  | <b>Initial Start-up .....</b>               | <b>31</b> |
| <b>6.</b>  | <b>Adjustment Speed Controller.....</b>     | <b>32</b> |
| <b>7.</b>  | <b>Quick Reference .....</b>                | <b>33</b> |
| <b>8.</b>  | <b>Passwords.....</b>                       | <b>34</b> |

### 1. General

The frequency inverter KEB COMBIVERT F5-MULTI is a drive component, which is intended for installation in electrical systems or machines. The frequency inverter is exclusively for stepless speed control / regulation of three-phase asynchronous motors. The operation of other electrical consumers is not permitted and can lead to the destruction of the unit.

KEB COMBIVERT F5-MULTI has very extensive programming options. To make the operation and start-up simpler for the user, a special operator level was created in which the most important parameters are found. However, if the parameters pre-defined by KEB are not sufficient for your application an application manual is available.

## 2. Installation and Connection

### 2.1 Summary

#### 2.1.1 Housing Size D - E

|  |  |
|--|--|
| <p><b>Optional Operator</b><br/>with 9-pole Sub-D Socket<br/>Parameter Interface</p> |  |
| <p>X2A<br/>Connection<br/>Connection of control terminal</p>                         |  |
| <p>X3B<br/>9-pole Sub-D Socket<br/><b>OPTION</b></p>                                 |  |
| <p>X3A<br/>15-pole Sub-D Socket<br/>Connection of incremental encoder</p>            |  |

GB

#### 2.1.2 Housing Size >= G

|  |  |  |
|--|--|--|
| <p><b>Optional Operator</b><br/>with 9-pole Sub-D Socket<br/>Parameter Interface</p> |  |  |
| <p>X3A<br/>15-pole Sub-D Socket<br/>Connection of incremental encoder</p>            |  |  |
| <p>X3B<br/>9-pole Sub-D Socket<br/><b>OPTION</b></p>                                 |  |  |
| <p>X2A<br/>Connection<br/>Connection of control terminal</p>                         |  |  |
|  | <p>Observe the maximal width of connectors for X3A and X3B</p> |  |

## 2.2 Control Circuit MULTI

X2A

### 2.2.1 Assignment of Terminal Strip X2A



| PIN   | Function                | Name  | Description   |
|---|-------------------------|---|---|
| <b>Analog inputs</b>  |                         |   |   |
| 1   | + Set value input 1     | AN1+  | 0...±10 VDC ^ 0...±CP.22<br>Resolution 12 Bit<br>Scan time 1 ms       |
| 2   | - Set value input 1     | AN1-  |   |
| 3   | + Analog input 2        | AN2+  |   |
| 4   | - Analog input 2        | AN1-  |   |
| <b>Analog outputs</b>   |                         |   |   |
| 5   | Analog output 1         | ANOUT1  | Analog output of the real speed<br>0...±10 VDC ^ 0...±3000 rpm        |
| 6   | Analog output 2         | ANOUT2  | Analog output of the apparent current<br>0...10 VDC ^ 0...2 x IN      |
| 5 mA; Ri=100 Ω<br>Resolution 12 Bit<br>PWM frequency 3,4 kHz<br>Limiting frequency<br>Filter 1. Harmonic 178 Hz |                         |   |   |
| <b>Voltage supply</b>   |                         |   |   |
| 7   | +10 V Output            | CRF   | Reference voltage for setpoint potentiometer                          |
| 8   | Analog Mass             | COM   | Mass for analog in- and outputs                                       |
| 9   |                         |   |   |
| <b>Digital inputs</b>   |                         |   |   |
| 10  | Fixed Speed 1           | I1  | I1+I2 = fixed speed 3 (default: 0 rpm)<br>no input = analog set value |
| 11  | Fixed speed 2           | I2  |   |
| 12  | External fault          | I3  | Input for external fault stopping mode <sup>1)</sup>                  |
| 13  | -                       | I4  | No function deposited in the CP-Mode                                  |
| 14  | Limit switch forward    | F   | Software limit switch <sup>1)</sup>                                   |
| 15  | Limit switch reverse    | R   |   |
| 16  | Control release / Reset | ST  | Power modules are enabled;<br>Error Reset at opening                  |
| 17  | reset                   | RST   | Reset; only when an error occurs                                      |
| <b>Transistor outputs</b>   |                         |   |   |
| 18  | Speed dependent         | O1  | Transistor output switched at actual speed = set speed                |
| 19  | Ready signal            | O2  | Transistor output switched, as long as no error occurs                |
| <b>Voltage supply</b>   |                         |   |   |
| 20  | 24 V-Output             | Uout  | Approx. 24V output (max.100 mA))                                      |
| 21  | 20...30V-Input          | Uin   | Voltage input for external supply                                     |
| 22  | Digital Mass            | 0V  | Potential for digital in-/outputs                                     |
| 23  |                         |   |   |
| <b>Relay Outputs</b>  |                         |   |   |
| 24  | NO contact 1            | RLA   | Fault relay (default);<br>Function can be changed with CP.33          |
| 25  | NC contact 1            | RLB   |   |
| 26  | Switching contact 1     | RLC   |   |
| 27  | NO contact 2            | FLA   | Run-Signal (default);<br>Function can be changed with CP.34           |
| 28  | NC contact 2            | FLB   |   |
| 29  | Switching contact 2     | FLC   |   |
| at maximum<br>30VDC<br>0.01...1A  |                         |   |   |
|   |                         | 1) The reaction can be adjusted with CP.35 and CP. 36.. If the unit is defective there is no guarantee that the software protective function will work. |   |

## 2.2.2 Connection of the control circuit

In order to prevent a malfunction caused by interference voltage supply on the control inputs, the following directions should be observed:



EMC

- Use shielded / drilled cables
- Lay shield on one side of the inverter onto earth potential
- Lay control and power cable separately (about 10...20 cm apart); Lay crossings in a right angle (in case it cannot be prevented)

## 2.2.3 Digital Inputs

Using of the internal voltage supply

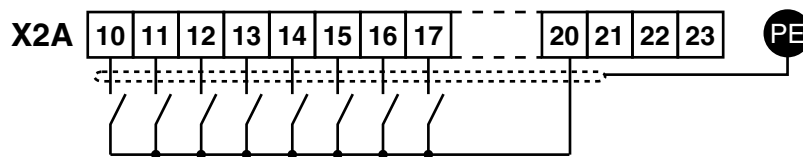

Using of an external voltage supply

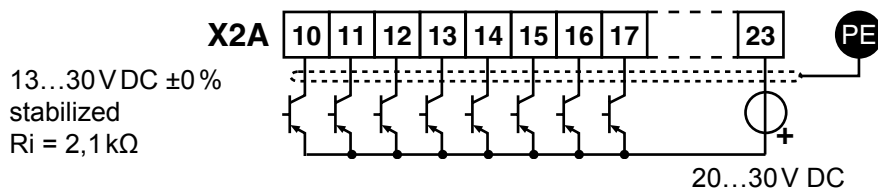

## 2.2.4 Analog Inputs

Connect unused analog inputs to common, to prevent set value fluctuations!

Analog set value setting in speed regulated operation (CP.10 = 4):

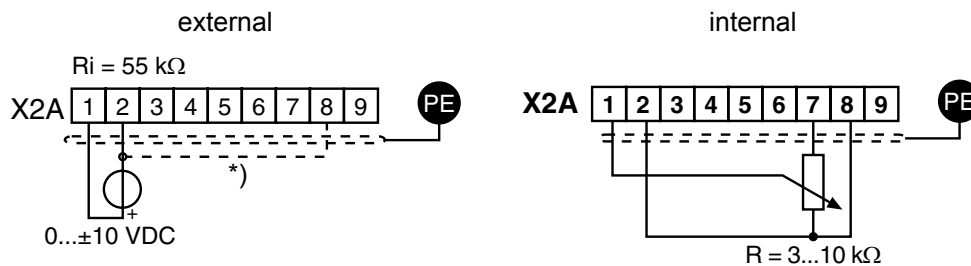

Analog set value setting in torque regulated operation (CP.10 = 5) and reference source CP.28 = 1:

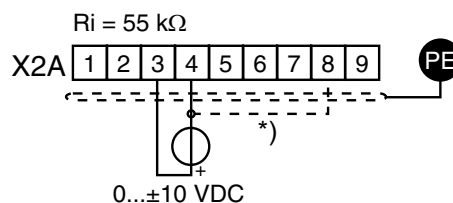

- \*) Connect potential equalizing line only if a potential difference of >30 V exists between the controls. The internal resistance is reduced to 30 kΩ.

## 2.2.5 Voltage Input / External Power Supply

The supply of the control circuit through an external voltage source keeps the control in operational condition even if the power stage is switched off. To prevent undefined conditions at external power supply the basic procedure is to first switch on the power supply and after that the inverter.

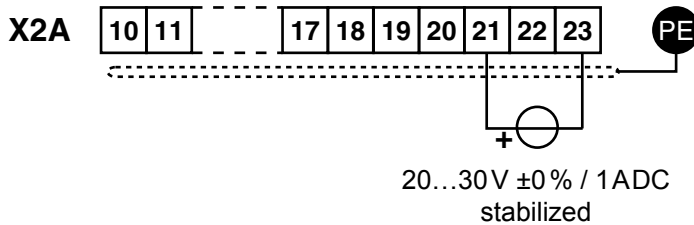

## 2.2.6 Digital Outputs

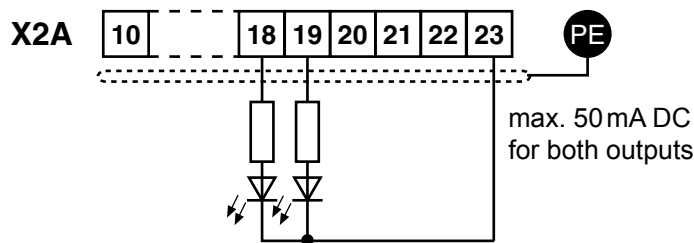

## 2.2.7 Relay Outputs

In case of inductive load on the relay outputs a protective wiring must be provided (e.g. free-wheeling diode)!

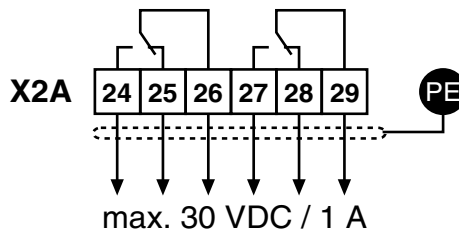

## 2.2.8 Analog Outputs

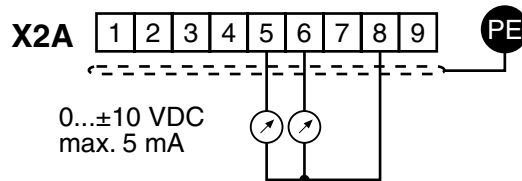

## 2.2.9 Voltage Output

The voltage output serves for the setting of the digital inputs as well as for the supply of external control elements. Do not exceed the maximum output current of 100 mA.

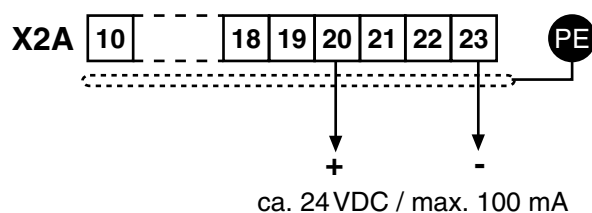



## 2.3 Operator

As an accessory to the local or external (option: cable 00.F5.0C0-1xxx) operation an operator is necessary. To prevent malfunctions, the inverter must be brought into nOP status before connecting / disconnecting the operator (open control release terminal). When starting the inverter, it is started with the last stored values or factory setting.

| Digital operator (part number 00.F5.060-1000) |   | Interface operator (part number 00.F5.060-2000)                   |  |
|---|---|---|--|
| x   | x | 5-digit LED Display   |  |
| x   | x | Operating-/Error display<br>Normal "LED on"<br>Error "LED blinks" |  |
| -   | x | Interface control<br>Transmit "LED on"                            |  |
| x   | x | Double function keyboard  |  |
| -   | x | X6B HSP5 programming and diagnostic interface                     |  |
| -   | x | X6C RS232/RS485   |  |



Only use the operator interface for the serial data transfer to RS232/485. The direct connection, PC to the inverter is only valid with a special cable (part number 00.F5.0C0-0001), otherwise, it would lead to the destruction of the PC-interface!

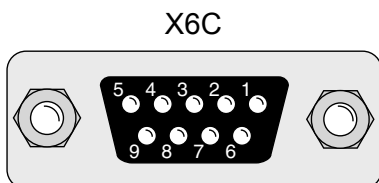

| PIN | RS485 | Signal | Meaning                                      |
|-----|-------|--------|--|
| 1   | -     | -      | reserved                                     |
| 2   | -     | TxD    | transmission signal RS232                    |
| 3   | -     | RxD    | receive signal RS232                         |
| 4   | A'    | RxD-A  | receive signal A RS485                       |
| 5   | B'    | RxD-B  | receive signal B RS485                       |
| 6   | -     | VP     | Voltage supply +5V (I <sub>max</sub> =10 mA) |
| 7   | C/C'  | DGND   | Data reference potential                     |
| 8   | A     | TxD-A  | transmission signal A RS485                  |
| 9   | B     | TxD-B  | transmission signal B RS485                  |

RS 232 cable  
Part number  
00.58.025-001D  
Length 3m

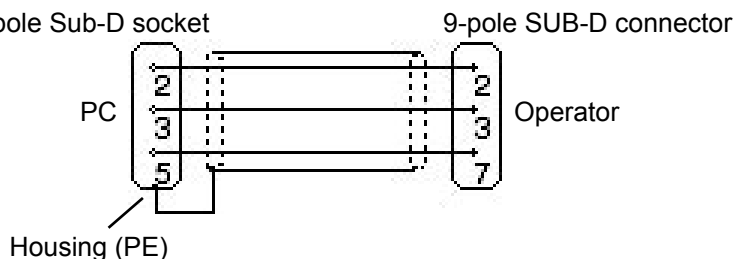

## 3. Operation of the Unit

### 3.1 Keyboard

When switching on KEB COMBIVERT F5 the value of parameter CP.1 appears (see Drive mode to switch the keyboard function).

The function key (FUNC) changes between the parameter value and parameter number.



With UP (▲) and DOWN (▼) the value of the parameter number is increased/decreased with changeable parameters.

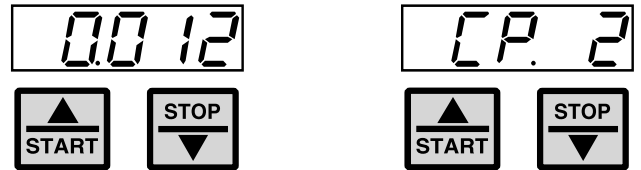

Principally during a change, parameter values are immediately accepted and stored non-volatile. However, with some parameters it is not useful that the adjusted value is accepted immediately. In these cases (CP.28, CP.32, CP.33, CP.34) the adjusted value is accepted and stored non-volatile by pressing ENTER.

If a malfunction occurs during operation, then the actual display is overwritten by the alarm message. The alarm message in the display is reset by ENTER.

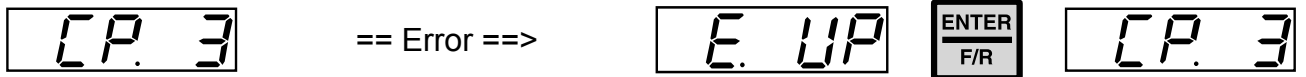

With ENTER only the error message in the display is reset. In the inverter status display (CP.3) the error is still displayed. In order to reset the error itself, the cause must be removed or a power-on reset must be made.

## 3.2 Parameter description

| Parameter | Setting range                  | Resolution          | Default    |                   |   |
|-----------|--------------------------------|---------------------|------------|-------------------|---|
| CP.00     | Password Input                 | 0...9999            | –          |                   |   |
| CP.01     | Encoder 1 speed                | –                   | 0,125 1rpm |                   |   |
| CP.02     | Setpoint display               | –                   | 0,125 1rpm |                   |   |
| CP.03     | Inverter state                 | –                   | 1          |                   |   |
| CP.04     | Apparent current               | –                   | 0.1 A      |                   |   |
| CP.05     | Peak apparent current          | –                   | 0.1 A      |                   |   |
| CP.06     | Actual torque                  | –                   | 0.01 Nm    |                   |   |
| CP.07     | Actual DC voltage              | –                   | 1 V        |                   |   |
| CP.08     | Peak DC voltage                | –                   | 1 V        |                   |   |
| CP.09     | Output voltage                 | –                   | 1 V        |                   |   |
| CP.10     | Speed control configuration    | 0 (off)...5         | 1          | 0 (off)           |   |
| CP.11     | DASM Rated speed               | 0...64000 rpm       | 1 rpm      | LTK <sup>2)</sup> |   |
| CP.12     | DASM rated frequency           | 0.0...1600.0 Hz     | 0.1 Hz     | LTK <sup>2)</sup> |   |
| CP.13     | DASM rated current             | 0.0...710.0 A       | 0.1 A      | LTK <sup>2)</sup> |   |
| CP.14     | DASM Rated voltage             | 120...500 V         | 1 V        | LTK <sup>2)</sup> |   |
| CP.15     | DASM Rated cos (phi)           | 0.50...1.00         | 0.01       | LTK <sup>2)</sup> |   |
| CP.16     | DASM Rated power               | 0.35...400.00 kW    | 0.01 kW    | LTK <sup>2)</sup> |   |
| CP.17     | Load motor dependent parameter | 0...2               | 1          | 0                 |   |
| CP.18     | Boost                          | 0.0...25.5 %        | 0.1 %      | 2%                |   |
| CP.19     | rated frequency                | 0...400 Hz          | 0.0125 Hz  | 50 Hz             |   |
| CP.20     | Encoder 1 (inc/r)              | 1...16383 inc.      | 1 inc.     | 2500 inc.         |   |
| CP.21     | Encoder 1 rotation             | 0...19              | 1          | 0                 | x |
| CP.22     | Maximum speed                  | 0...4000 rpm        | 0.125 rpm  | 2100 rpm          |   |
| CP.23     | Step value 1                   | +4000 rpm           | 0.125 rpm  | 100 rpm           |   |
| CP.24     | Step value 2                   | +4000 rpm           | 0.125 rpm  | -100 rpm          |   |
| CP.25     | Acceleration time              | 0.00...300.00 s     | 0.01 s     | 5.00 s            |   |
| CP.26     | Deceleration time              | -0.01...300.00 s    | 0.01 s     | 5.00 s            |   |
| CP.27     | S-curve time                   | 0.00 (off)...5.00 s | 0.01 s     | 0.00 s (off)      |   |
| CP.28     | Torque reference source        | 0...5               | 1          | 2                 | x |
| CP.29     | Absolute torque reference      | +10000.00           | 0.01 Nm    | LTK <sup>2)</sup> |   |
| CP.30     | KP speed                       | 0...32767           | 1          | 300               |   |
| CP.31     | KI speed                       | 0...32767           | 1          | 100               |   |
| CP.32     | Switching frequency            | 2/4/8/12/16 kHz     | –          | – <sup>2)</sup>   | x |
| CP.33     | Relay output 1 / Function      | 0...75              | 1          | 4                 | x |
| CP.34     | Relay output 2 / Function      | 0...75              | 1          | 2                 | x |
| CP.35     | Reaction to limit switch       | 0...6               | 1          | 6                 |   |
| CP.36     | Reaction to external fault     | 0...6               | 1          | 0                 |   |

<sup>2)</sup> depending on size (see 3.3 "Factory Settings")



Due to the calculation / measuring accuracies, tolerances with the current and torque displays as well as with the switching levels and limitations, must be taken into consideration. The given tolerances (see parameter description) refer to the respective maximum values with the dimensioning KEB COMBIVERT : Motor = 1 : 1.

Dependent on the data from the motor manufacturer, larger tolerances at the torque displays are possible, due to the usual variations in the machine parameters and temperature drifts.

GB

# Parameter description

## 3.2.1 Password Input

### CP.00 Password Input

Ex works the frequency inverter is supplied without password protection, this means that all changeable parameters can be adjusted. After parameterizing the unit can be barred against unauthorized access (Passwords: see last but one page). The adjusted mode is stored.

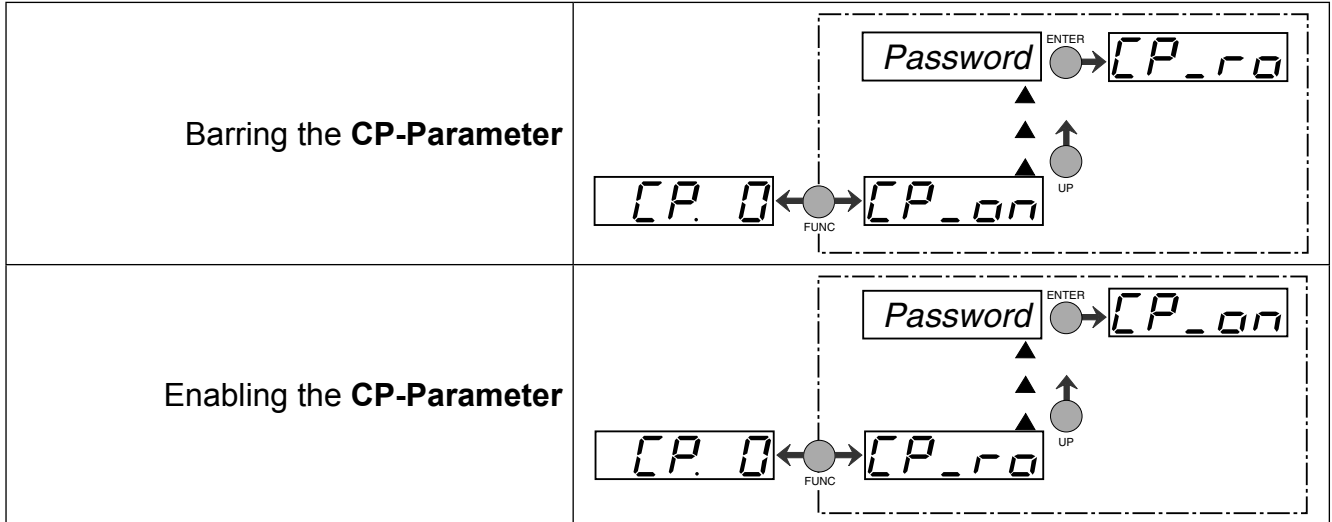

## 3.2.2 Operating Display

The parameters below serve for the controlling of the frequency inverter during operation.

### CP.01 Encoder 1 speed

| Co-domain     | Description  |
|---------------|--|
| 0...±4000 rpm | Display of actual motor speed ( incremental encoder 1). For control reasons the set speed is displayed, even if the control release or direction of rotation are not switched. A counter-clockwise rotating field (reverse) is represented by a negative sign. Precondition for the correct display value is the in-phase connection of the motor and the correct setting of the encoder line number (CP.20) as well as the direction of rotation (CP.21). |

### CP.02 Setpoint display

| Co-domain     | Description  |
|---------------|--|
| 0...±4000 rpm | Display of actually set value. For control reasons the set speed is displayed, even if the control release or direction of rotation are not switched. If no direction of rotation is set, the set speed for clockwise rotation (forward) is displayed. |

### CP.03 Inverter status

The status display shows the actual working conditions of the inverter. Possible displays and their meanings are:

|  |   |
|--|---|
|  | „no Operation“ control release not bridged; modulation switched off; output voltage = 0V; drive is not controlled.  |
|  | „Low Speed“ no direction of rotation preset; modulation switched off; output voltage = 0V; drive is not controlled. |
|  | "Forward Acceleration" drive accelerates with direction of rotation forward.  |
|  | „Forward Deceleration“ drive decelerates with direction of rotation forward.  |
|  | further on next side  |

|  |  |
|--|--|
|  | "Reverse Acceleration" drive accelerates with direction of rotation reverse.           |
|  | "Reverse Deceleration" drive decelerates with direction of rotation reverse.           |
|  | "Forward Constant" drive runs with a constant speed and direction of rotation forward. |
|  | "Reverse Constant" drive runs with constant speed and direction of rotation reverse.   |

Other status messages are described at the parameters, where they occur (see chapter 4 „Error diagnosis“).

GB

## CP.04 Apparent current

| Co-domain    | Description                                       |
|--------------|---|
| 0...±6553.5A | Display of the actual apparent current in ampere. |

## CP.05 Apparent current / peak value

| Co-domain    | Description   |
|--------------|---|
| 0...±6553.5A | CP.5 makes it possible to recognize the max. apparent current. For that the highest value of CP.4 is stored in CP.5 . The peak value memory can be cleared by pressing the UP, DOWN or ENTER key or over bus by writing any value you like to the address of CP.5. The switch off of the inverter also clears the memory. |

## CP.06 Actual torque

| Co-domain        | Description  |
|------------------|--|
| 0.0...±10000.00A | The displayed value corresponds to the actual motor torque in Nm. The value is calculated from the active current. Because of normal type differences and temperature deviations of the motors, tolerances of up to 30 % are possible in the base speed range (see reference at 3.2).<br>Requirement for the torque display is the adjustment of the motor data (CP.11...CP.16). If the real motor data deviate strongly from the data on the name plate the operating performance can be optimized by entering the real data. The adjustment of the name plate data is sufficient for a start-up. |

## CP.07 Intermediate circuit voltage

| Display   | Description  |                  |                    |                     |
|-----------|--|------------------|--------------------|---------------------|
| 0...1000V | Display of actual DC-link voltage in volt. Typical values: |                  |                    |                     |
|           | V-class  | Normal operation | Overvoltage (E.OP) | Undervoltage (E.UP) |
|           | 230V   | 300...330V DC    | approx. 400V DC    | approx. 216V DC     |
| 400V      | 530...620V DC  | approx. 800V DC  | approx. 240V DC    |                     |

## CP.08 DC-link voltage / peak value

| Display   | Description   |
|-----------|---|
| 0...1000V | CP.8 makes it possible to recognize short-time voltage rises within an operating cycle. For that the highest value of CP.7 is stored in CP.8. The peak value memory can be cleared by pressing the UP, DOWN or ENTER key or over bus by writing any value you like to the address of CP.8. The switch off of the inverter also clears the memory. |

## Parameter description

### CP.09 Output voltage

| Co-domain | Description                                   |
|-----------|---|
| 0...778V  | Display of the actual output voltage in volt. |

### 3.2.3 Basic Adjustment of the Drive

The following parameters determine the fundamental operating data of the drive and must be adjusted for the initial commissioning (see chapter 5 "Start-up" ). They should be checked and/or adapted to the application.

### CP.10 Speed control configuration

| Input   | Setting | Function                                      | Description  |
|---------|---------|---|--|
| 0       | x       | off (open loop operation)                     | With this parameter the basic setting of the speed controller is determined. |
| 1       |         | -reserved-                                    |  |
| 2       |         | -reserved-                                    |  |
| 3       |         | off (open loop operation)                     |  |
| 4       |         | Speed control (closed loop operation)         |  |
| 5       |         | Torque control (closed loop operation)        |  |
| 6       |         | Torque-/speed control (closed loop operation) |  |
| 7...127 |         | off (open loop operation)                     |  |

### CP.11 DASM rated motor speed

| Co-domain    | Setting | Description  |
|--------------|---------|--|
| 0...64000rpm | see 3.3 | Adjustment of rated motor speed according to the name plate. The factory setting depends on the unit size ( see 3.3 „Factory Settings“). |

### CP.12 DASM rated frequency

| Co-domain      | Setting | Description  |
|----------------|---------|--|
| 0.0...1600.0Hz | see 3.3 | Adjustment of the rated motor frequency according to the name plate. The factory setting depends on the unit size ( see 3.3 „Factory Settings“). |

### CP.13 DASM rated current

| Co-domain     | Setting | Description  |
|---------------|---------|--|
| 0.0...710.0 A | see 3.3 | Adjustment of the rated motor current according to the name plate and the connection (Y / $\Delta$ ). The factory setting depends on the unit size (see 3.3 „Factory Settings“). |

### CP.14 DASM rated voltage

| Co-domain   | Setting | Description  |
|-------------|---------|--|
| 120...500 V | see 3.3 | Adjustment of the rated motor current according to the name plate and the connection (Y / $\Delta$ ). The factory setting depends on the unit size (see 3.3 „Factory Settings“). |

### CP.15 DASM cos (phi)

| Co-domain   | Setting | Description   |
|-------------|---------|---|
| 0.50...1.00 | see 3.3 | Adjustment of the motor cos(phi) according to the name plate. The factory setting depends on the unit size ( see 3.3 „Factory Settings“). |

## CP.16 DASM rated power

| Co-domain     | Setting | Description  |
|---------------|---------|--|
| 0.35...400 kW | see 3.3 | Adjustment of the rated motor power according to the name plate. The factory setting depends on the unit size ( see 3.3 „Factory Settings“). |

## CP.17 Load motor dependent parameter

The basic settings of the inverter correspond to the size of the unit and the respective motor (see 3.3 „Factory Settings“). If the motor data in CP.11...16 are changed, then CP.17 must be activated once. This re-adjusts the current controller, torque curve and torque limit. With this, the torque limit is set at the value, that is maximally possible in the speed range (depending on inverter rated current), but not above the rated motor torque x 3.

| Co-domain   | Setting | Description   |
|---|---------|---|
| 1   | x       | Pre-adjustment of the motor-dependent control-parameters. The voltage class of the inverter is taken as input voltage.  |
| 2   |         | Pre-adjustment of the motor-dependent control-parameters. The measured DC-link voltage divided by $\sqrt{2}$ measured at switch on is taken as input voltage. Thus the frequency inverter can be adapted to the actually available mains voltage (e.g. USA with 460 V). |
|  |         | When control release is active the adjustment was not completed. „nco“ appears in the display.  |

## CP.18 Boost

| Co-domain   | Setting | Description  |
|---|---------|--|
| 0.0...25.5 %  | 2 %     | In the lower speed range a large part of the motor voltage decreases on the stator resistance. So that the breakdown torque of the motor remains nearly constant in the controlled operation over the entire speed range, the voltage drop can be compensated by the Boost. <b>During regulated operation (CP.10 = 4 or 5) this parameter has no function.</b><br>Adjustment: <ul style="list-style-type: none"> <li>• Determine the rate of utilization in no-load operation with rated speed</li> <li>• Preset about 300 rpm and adjust the boost, so that about the same rate of utilization is reached as with the rated speed.</li> </ul> |
|  |         | When the motor, during continuous operation, drives with low speed and too high voltage it can lead to an overheating of the motor.  |

# Parameter description

## CP.19 rated frequency

| Co-domain   | Setting   | Description   |
|---|---|---|
| 0.00...400.00Hz   | 50Hz  | With the adjusted frequency the inverter reaches in controlled operation a maximal output voltage. The adjustment of the rated motor frequency is typical in this case. |
| <p>The graph shows the relationship between output voltage (UA) and frequency (f). The vertical axis is labeled UA and has a tick mark at 100%. The horizontal axis is labeled f and has a tick mark at CP.19. A solid line starts at the origin (0,0) and rises linearly to the point (CP.19, 100%). From this point, a horizontal line extends to the right, indicating that the output voltage remains constant at 100% for frequencies above CP.19. Dashed lines indicate the coordinates of the point (CP.19, 100%).</p> |   |   |
|   | Motors can overheat when the rated frequency is incorrectly adjusted. During regulated operation (CP.10 = 4 or 5) this parameter has no function. |   |

## CP.20 Encoder line number 1

| Co-domain     | Setting  | Description   |
|---------------|--|---|
| 1...16383 inc | 2500 inc   | With this parameter the encoder line number is adjusted to the encoder that is connected to channel 1. Check the set and actual speed displays during controlled operation and compare. The correct settings must be actual speed = set speed - slip. |
|               | The co-domain can vary due to different encoder identifiers. |   |

## CP.21 Encoder 1 rotation

| Bit   | Value | Function                  | Description   |
|---|-------|---------------------------|---|
| 0   |       | Encoder rotation          | If you find that during start-up in controlled operation the actual and setpoint speed have different signs it can be an indication for a wrong connection of the incremental encoder. If possible the wiring should be corrected. Should this involve too much effort then you can achieve a rotation reversal of encoder 1 by means of this parameter. The effect corresponds to a change of the A and B tracks of the incremental encoder.<br>A system inverting can be adjusted with bit 4. With this it is possible to run the motor with positive setting counter-clockwise at the shaft. |
|   | 0     | no modification (default) |   |
| 1   | 1     | inverted                  |   |
| 1   | 0     | -reserved-                |   |
| 2   | 0     | -reserved-                |   |
| 3   | 0     | -reserved-                |   |
| 4   |       | system inverting          |   |
|   | 0     | no modification (default) |   |
|   | 16    | inverted                  |   |
| The bit values are to be added up and confirm by "ENTER". |       |                           |   |



## 3.2.4 Special Adjustments

The following parameters serve for the optimization of the drive and the adaption to certain applications. These adjustments can be ignored at the initial start-up.

### CP.22 Maximum speed

| Co-domain    | Setting  | Description  |
|--------------|----------|--|
| 0...4000 rpm | 2100 rpm | In order to limit the setpoint value a maximum speed must be preset. This limit value is the basis for further setpoint calculations and for the determination of setpoint characteristics. The maximum speed limits the setpoint speed only. Because of speed ripples, speed overshoot or hardware defects (e.g. defective encoder) the actual speed may exceed these limits. |

GB

### CP.23 Fixed speed 1 (input 1)

### CP.24 Fixed speed 2 (input 2)

|       | Co-domain   | Setting  | Description   |
|-------|---|----------|---|
| CP.23 | 0...±4000 rpm   | 100 rpm  | Two fixed speeds can be adjusted. The selection is made by the inputs I1 and I2. If adjustments are made that are outside the fixed limit of CP.22, then the speed is internally limited. |
| CP.24 |   | -100 rpm |   |
|       | Input I1 + input I2 = fixed speed 3 (factory setting = 0 rpm)<br>The Step speed 3 cannot adjusted in the CP-mode. |          |   |

### CP.25 Acceleration time



| Co-domain  | Setting | Description  |
|--|---------|--|
| 0.00...300.00 s  | 5.00 s  | Defines the time needed to accelerate from 0 to 1000 rpm. The actual acceleration time is proportional to the speed change ( $\Delta n$ ).   |
| $\Delta n$ Speed change<br>$\Delta t$ Acceleration time for $\Delta n$ |         | <p>The graph shows a speed profile where the speed <math>n</math> in rpm is plotted against time <math>t</math> in seconds. The speed starts at 300 rpm and remains constant until <math>t = 0.5</math> s. It then accelerates linearly to 800 rpm at <math>t = 1.5</math> s. The time interval for this acceleration is labeled <math>\Delta t</math>. The total time for the drive to reach 1000 rpm is labeled CP.25.</p> |
| Example  |         | <p>The drive should accelerate from 300 rpm auf 800 rpm in 1 s.</p> <p><math>\Delta n = 800 \text{ rpm} - 300 \text{ rpm} = 500 \text{ rpm}</math><br/> <math>\Delta t = 1 \text{ s}</math></p> <p><math display="block">\text{CP.25} = \frac{\Delta t}{\Delta n} \times 1000 \text{ rpm} = \frac{1 \text{ s}}{500 \text{ rpm}} \times 1000 \text{ rpm} = 2 \text{ s}</math></p>   |

# Parameter description

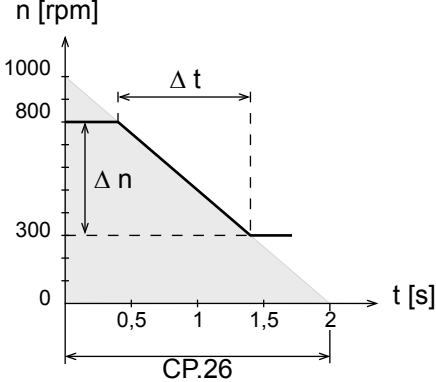
## CP.26 Deceleration time

| Co-domain  | Setting | Description   |
|--|---------|---|
| -0.01...300.00 s   | 5.00 s  | Defines the time needed to accelerate from 1000 to 0rpm. The actual deceleration time is proportional to the speed change ( $\Delta n$ ). At a deceleration time of -1 the value from CP.25 is used (Display „=Acc“)!   |
| $\Delta n$ Speed change<br>$\Delta t$ Deceleration time for $\Delta n$ |         |   |
|  | Example | <p>The drive should decelerate from 800 rpm to 300 rpm in 1 s.</p> <p><math>\Delta n = 800 \text{ rpm} - 300 \text{ rpm} = 500 \text{ rpm}</math><br/> <math>\Delta t = 1 \text{ s}</math></p> <p><math display="block">\text{CP.26} = \frac{\Delta t}{\Delta n} \times 1000 \text{ rpm} = \frac{1 \text{ s}}{500 \text{ rpm}} \times 1000 \text{ rpm} = 2 \text{ s}</math></p> |

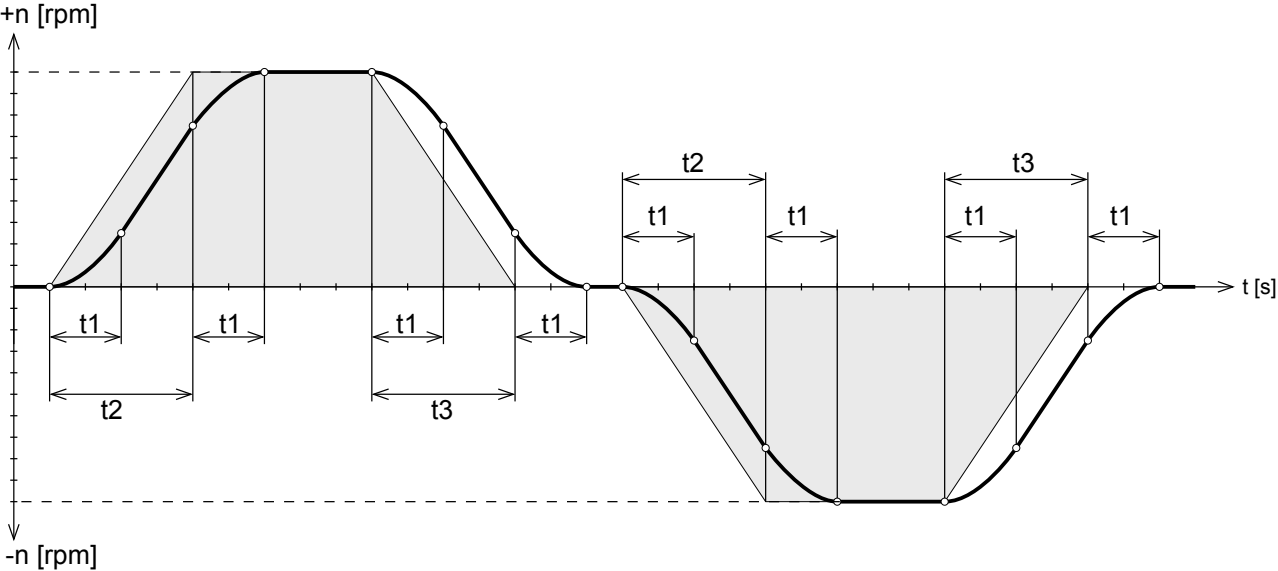
## CP.27 S-curve time

| Co-domain  | Setting      | Description  |
|--|--------------|--|
| 0.00 (off)...5.00 s  | 0.00 s (off) | For some applications it is of advantage when the drive starts and stops jerk-free. This is achieved through a straightening of the acceleration and deceleration ramps. The straightening time, also called S-curve time, can be adjusted with CP.27. |
| $t_1$ S-curve time (CP.27)<br>$t_2$ Acceleration time (CP.25)<br>$t_3$ Deceleration time (CP.26)   |              |  |
|    |              |  |
|  <p>In order to drive defined ramps with activated S-curve time, the acceleration and deceleration times (CP.25 and CP.26) must be adjusted higher than the S-curve time (CP.27).</p> |              |  |

## CP.28 Torque reference source

| Value | Source                | Setting range           | Description  |
|-------|-----------------------|-------------------------|--|
| 0     | AN1+ / AN1-           | 0%...±100% = 0...±CP.29 | With this parameter the required setpoint source for torque control can be adjusted. |
| 1     | AN2+ / AN2-           | 0%...±100% = 0...±CP.29 |  |
| 2     | digital absolute      | CP.29                   |  |
| 3...5 | only application mode |                         |  |

The values must be confirm by „ENTER“.

## CP.29 Absolute torque reference

| Co-domain   | Setting | Description  |
|---|---------|--|
| ±10000.00 Nm  | see 3.3 | The absolute torque reference of the drive is adjusted with parameter CP.29 in torque controlled operation (CP.10 = 5) and with digital setpoint setting (CP.28 = 2). The sign stands for direction of rotation to be active.<br>In speed controlled operation (CP.10 = 4) the parameter works as torque limit in all quadrants. The sign has no effect at that.<br>The factory setting depends on the unit size (see 3.3 „Factory Settings“).<br><b>During controlled operation (CP...10) this parameter has no function.</b> |
|  |         | Because of normal type differences and temperature deviations of the motors, tolerances of up to 30% are possible in the base speed range (see reference on page 13).  |

## CP.30 KP speed

| Co-domain | Setting | Description   |
|-----------|---------|---|
| 0...32767 | 300     | The proportional factor of the speed controller is adjusted in these parameters (see chapter 5 „Start-up“). |

## CP.31 KI speed

| Co-domain | Setting | Description   |
|-----------|---------|---|
| 0...32767 | 100     | The integral factor of the speed controller is adjusted in these parameters (see chapter 5 „Start-up“). |

## CP.32 Switching frequency

| Co-domain   | Setting   | Description   |
|---|---|---|
| 2 / 4 / 8 / 12 / 16 kHz   |   | The switching frequency with which the power modules are clocked can be changed depending on the application. The employed power stage determines the maximum switching frequency as well as the factory setting (see manual: part 2). The values must be confirm by „ENTER“. |
| Refer to following list to learn about influences and effects of the switching frequency. | <b>low switching frequency</b>                          | <b>high switching frequency</b>   |
|   | less inverter heating                                   | less noise development  |
|   | less discharge current                                  | improved sine-wave simulation   |
|   | less switching losses                                   | less motor losses   |
|   | less radio interferences                                | improved controller characteristics   |
|   | improved concentricity with low speed (only open loop!) |   |
|        |   | At switching frequencies above 4 kHz pay absolute attention to the max. motor line length in the technical data of the power circuit manual (Part 2).   |

## CP.33 Relay output 1 / function

## CP.34 Relay output 2 / function

CP.33 and CP.34 determine the function of the two relay outputs (terminals X2A.24...26 and X2A.27...29). The values must be confirm by „ENTER“.

## Parameter description

| Value   | Function   |
|---------|--|
| 0       | No function (generally off)  |
| 1       | Generally on   |
| 2       | Run signal; also by DC-braking   |
| 3       | Ready signal (no error)  |
| 4       | Fault relay  |
| 5       | Fault relay (not at under voltage error)                                 |
| 6       | Warning or error message at abnormal stopping                            |
| 7       | Overload alert signal  |
| 8       | Overtemperature alert signal power modules                               |
| 9       | External overtemperature alert signal motor                              |
| 10      | Only application mode  |
| 11      | Overtemperature alert signal interior OHI                                |
| 12...19 | Only application mode  |
| 20      | Actual value = set value (CP.3 = Fcon; rcon; not at noP, LS, error, SSF) |
| 21      | Accelerate (CP.3 = FAcc, rAcc, LAS)                                      |
| 22      | Decelerate (CP.3 = FdEc, rdEc, LdS)                                      |
| 23      | Real direction of rotation = set direction of rotation                   |
| 24      | Utilization > switching level <sup>1)</sup>                              |
| 25      | Active current > switching level <sup>1)</sup>                           |
| 26      | Only application mode  |
| 27      | Real value (CP.1) > switching level <sup>1)</sup>                        |
| 28      | Setpoint (CP.2) > switching level <sup>1)</sup>                          |
| 29...30 | Only application mode  |
| 31      | Absolute setpoint at AN1 > switching level <sup>1)</sup>                 |
| 32      | Absolute setpoint at AN2 > switching level <sup>1)</sup>                 |
| 33      | Only application mode  |
| 34      | Setpoint at AN1 > switching level <sup>1)</sup>                          |
| 35      | Setpoint at AN2 > switching level <sup>1)</sup>                          |
| 36...39 | Only application mode  |
| 40      | Hardware current limit activated   |
| 41      | Modulation on-signal   |
| 42...46 | Only application mode  |
| 47      | Ramp output value > switching level <sup>1)</sup>                        |
| 48      | Apparent current (CP.4) > switching level <sup>1)</sup>                  |
| 49      | Forward running (not at nOP, LS, abnormal stopping or error)             |
| 50      | Reverse running (not at nOP, LS, abnormal stopping or error)             |
| 51      | Warning E.OL2  |
| 52      | Current regulator limit reached  |
| 53      | Speed regulator limit reached  |
| 54...62 | Only application mode  |
| 63      | Absolute value ANOUT1 > switching level <sup>1)</sup>                    |
| 64      | Absolute value ANOUT2 > switching level <sup>1)</sup>                    |
| 65      | ANOUT1 > switching level <sup>1)</sup>                                   |
| 66      | ANOUT2 > switching level <sup>1)</sup>                                   |
| 67...69 | Only application mode  |
| 70      | Driving current active (safety relay)                                    |
| 71...72 | Only application mode  |
| 73      | Absolut active power > switching level <sup>1)</sup>                     |
| 74      | Active power > switching level <sup>1)</sup>                             |
| 75...79 | Only application mode  |
| 80      | Active current > switching level <sup>1)</sup>                           |
|         | further on next side   |

| Value | Function   |
|-------|--|
| 81    | Real value channel 1 > switching level <sup>1)</sup> |
| 82    | Real value channel 2 > switching level <sup>1)</sup> |
| 83    | HSP5 bus synchronized                                |
| 84    | Only application mode                                |

1) Switching level of CP.33 = 100; switching level of CP.34 = 4

## Parameter description

### CP.35 Limit switch / stopping mode

This parameter determines the reaction of the drive, to terminal X2A.14 (F) and/or X2A.15 (R). These terminals are programmed as limit switches. The reaction of the drive is shown in the table below.

| Value | Setting | Display           | Reaction  | Restart                           |
|-------|---------|-------------------|---|-----------------------------------|
| 0     |         | E.PR <sub>x</sub> | Immediate disabling of modulation                               | Remove fault, reset               |
| 1     |         | A.PR <sub>x</sub> | Quick stopping / disabling of modulation after reaching speed 0 |                                   |
| 2     |         | A.PR <sub>x</sub> | Quick stopping / holding torque at speed 0                      |                                   |
| 3     |         | A.PR <sub>x</sub> | Immediate disabling of modulation                               | Autoreset, if no fault is present |
| 4     |         | A.PR <sub>x</sub> | Quick stopping / disabling of modulation after reaching speed 0 |                                   |
| 5     |         | A.PR <sub>x</sub> | Quick stopping / holding torque at speed 0                      |                                   |
| 6     | x       | —                 | No effect to the drive, fault is ignored!                       | —                                 |

### CP.36 Reaction to external fault

With the external error monitoring external units can take direct influence on the drive. This parameter determines the response of the drive to a signal at terminal X2A.12 (I3) according to following table.

| Value | Setting | Display           | Reaction  | Restart                           |
|-------|---------|-------------------|---|-----------------------------------|
| 0     | x       | E.PR <sub>x</sub> | Immediate disabling of modulation                               | Remove fault, reset               |
| 1     |         | A.PR <sub>x</sub> | Quick stopping / disabling of modulation after reaching speed 0 |                                   |
| 2     |         | A.PR <sub>x</sub> | Quick stopping / holding torque at speed 0                      |                                   |
| 3     |         | A.PR <sub>x</sub> | Immediate disabling of modulation                               | Autoreset, if no fault is present |
| 4     |         | A.PR <sub>x</sub> | Quick stopping / disabling of modulation after reaching speed 0 |                                   |
| 5     |         | A.PR <sub>x</sub> | Quick stopping / holding torque at speed 0                      |                                   |
| 6     |         | —                 | No effect to the drive, fault is ignored!                       | —                                 |

### 3.3 Factory Settings

In the table below the factory settings for the size-dependent parameter values are listed.

| Parameter                   | CP.11             | CP.12                 | CP.13               | CP.14               | CP.15                | CP.16       | —                 | CP.29          |
|-----------------------------|-------------------|-----------------------|---------------------|---------------------|----------------------|-------------|-------------------|----------------|
| Unit size/<br>voltage class | Rated motor speed | Rated motor frequency | Rated motor current | Rated motor voltage | Rated motor cos(Phi) | Rated motor | Rated motor power | Maximum torque |
|                             | [ rpm ]           | [Hz]                  | [A]                 | [V]                 | —                    | cos(Phi)    | [kW]              | [Nm]           |
| 09/200V                     | 1400              | 50                    | 5,9                 | 230                 | 0,83                 | 1,5         | 10,23             | 22,09          |
| 10/200V                     | 1420              | 50                    | 9,0                 | 230                 | 0,78                 | 2,2         | 14,79             | 30,68          |
| 12/200V                     | 1435              | 50                    | 15,2                | 230                 | 0,79                 | 4,0         | 26,61             | 53,53          |
| 13/200V                     | 1440              | 50                    | 18,2                | 230                 | 0,89                 | 5,5         | 36,47             | 69,92          |
| 14/200V                     | 1450              | 50                    | 26,0                | 230                 | 0,84                 | 7,5         | 49,39             | 93,40          |
| 15/200V                     | 1450              | 50                    | 37,5                | 230                 | 0,85                 | 11,0        | 72,43             | 137,48         |
| 16/200V                     | 1465              | 50                    | 50,0                | 230                 | 0,86                 | 15,0        | 97,76             | 190,64         |
| 17/200V                     | 1460              | 50                    | 60,5                | 230                 | 0,86                 | 18,5        | 120,99            | 248,74         |
|                             |                   |                       |                     |                     |                      |             |                   |                |
| 09/400V                     | 1400              | 50                    | 3,4                 | 400                 | 0,83                 | 1,5         | 10,23             | 22,47          |
| 10/400V                     | 1420              | 50                    | 5,2                 | 400                 | 0,78                 | 2,2         | 14,79             | 30,81          |
| 12/400V                     | 1435              | 50                    | 8,8                 | 400                 | 0,79                 | 4,0         | 26,61             | 53,21          |
| 13/400V                     | 1440              | 50                    | 10,5                | 400                 | 0,89                 | 5,5         | 36,47             | 73,26          |
| 14/400V                     | 1450              | 50                    | 15,0                | 400                 | 0,84                 | 7,5         | 49,39             | 80,12          |
| 15/400V                     | 1450              | 50                    | 21,5                | 400                 | 0,85                 | 11,0        | 72,43             | 118,83         |
| 16/400V                     | 1465              | 50                    | 28,5                | 400                 | 0,86                 | 15,0        | 97,76             | 165,88         |
| 17/400V                     | 1460              | 50                    | 35,0                | 400                 | 0,86                 | 18,5        | 120,99            | 213,37         |
| 18/400V                     | 1465              | 50                    | 42,0                | 400                 | 0,84                 | 22,0        | 143,83            | 253,27         |
| 19/400V                     | 1465              | 50                    | 55,5                | 400                 | 0,85                 | 30,0        | 195,52            | 309,88         |
| 20/400V                     | 1470              | 50                    | 67,0                | 400                 | 0,86                 | 37,0        | 240,33            | 393,60         |
| 21/400V                     | 1470              | 50                    | 81,0                | 400                 | 0,86                 | 45,0        | 292,29            | 474,91         |
| 22/400V                     | 1475              | 50                    | 98,5                | 400                 | 0,86                 | 55,0        | 356,03            | 609,86         |
| 23/400V                     | 1480              | 50                    | 140,0               | 400                 | 0,87                 | 75,0        | 483,85            | 752,75         |
| 24/400V                     | 1480              | 50                    | 168,0               | 400                 | 0,86                 | 90,0        | 580,63            | 907,29         |
| 25/400V                     | 1485              | 50                    | 210,0               | 400                 | 0,85                 | 110,0       | 707,26            | 833,38         |
| 26/400V                     | 1485              | 50                    | 240,0               | 400                 | 0,87                 | 132,0       | 848,72            | 1.041,70       |
| 27/400V                     | 1485              | 50                    | 287,0               | 400                 | 0,88                 | 160,0       | 1028,75           | 1.264,01       |
| 28/400V                     | 1485              | 50                    | 370,0               | 400                 | 0,88                 | 200,0       | 1285,93           | 1.413,37       |
| 29/400V                     | 1485              | 50                    | 420,0               | 400                 | 0,88                 | 250,0       | 1607,42           | 1.780,29       |
| 30/400V                     | 1490              | 50                    | 535,0               | 400                 | 0,88                 | 315,0       | 2018,55           | 1.938,63       |
| 31/400V                     | 1490              | 50                    | 623,0               | 400                 | 0,85                 | 355,0       | 2274,87           | 2.566,84       |
| 32/400V                     | 1490              | 50                    | 710,0               | 400                 | 0,84                 | 400,0       | 2563,24           | 3.012,88       |

GB

## 3.4 The drive mode

The Drive Mode is an operating mode of KEB COMBIVERT that permits the manual starting of the drive by the operator. After switching the control release the set value and rotation setting are effected exclusively over the keyboard. In order to activate the drive mode the corresponding password (see last but one page) must be entered in CP. 0. The display switches over as follows:

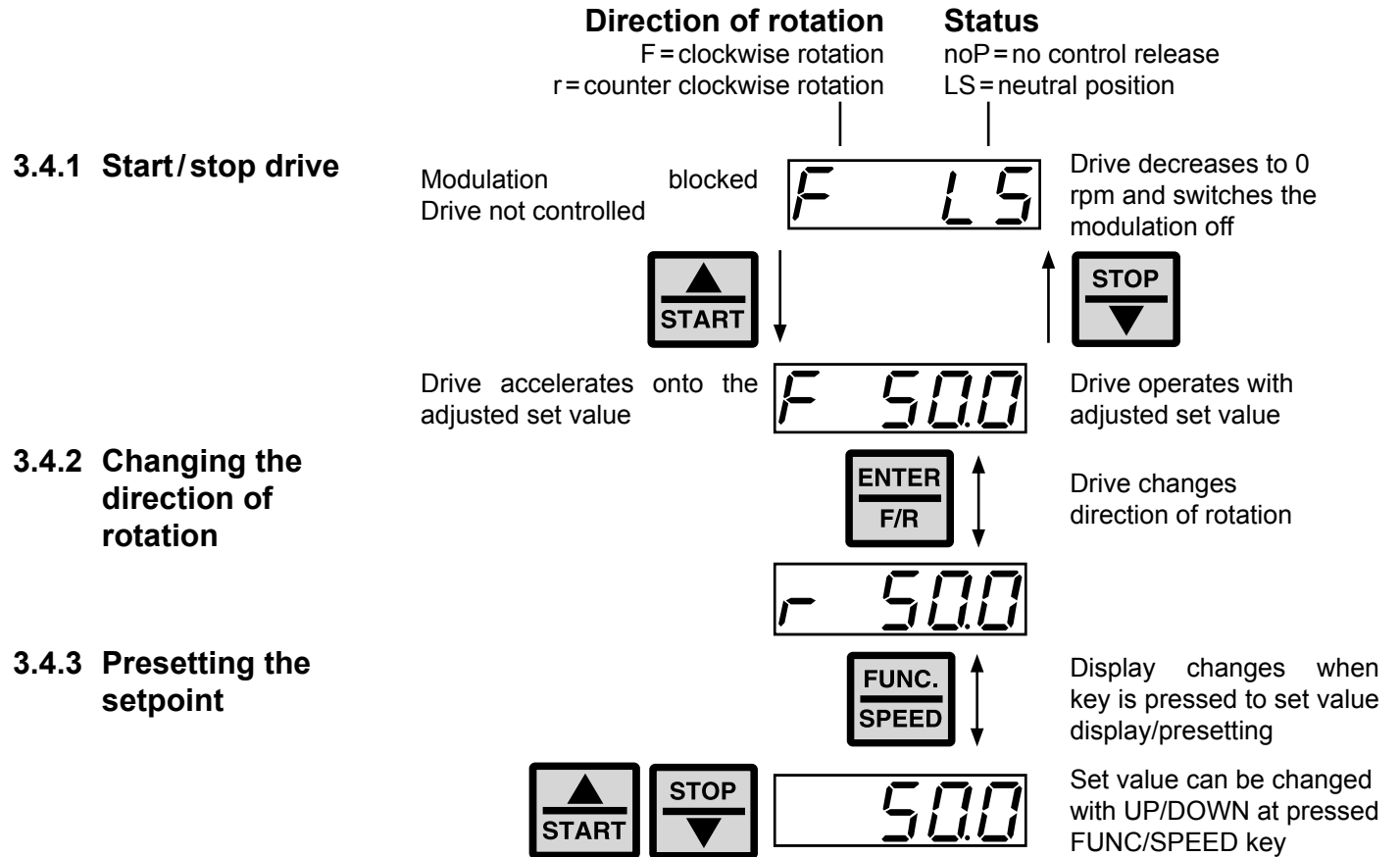

### 3.4.4 Leaving the drive mode

To exit the drive mode the inverter must be in status "stop" (Display noP or LS). Press the FUNC and ENTER keys simultaneously for about 3 seconds to leave the drive mode. The CP-parameters appear in the display.





#### 4. Error Assistance

At KEB COMBIVERT error messages are always represented with an "E." and the appropriate error in the display. Error messages cause the immediate deactivation of the modulation. Restart possible only after reset or autoreset.

Malfunction are represented with an „A.“ and the appropriate message. Reactions to malfunctions can vary. In the following the display and their cause are described.

| Display                | COMBIVIS               |     | Meaning  |
|------------------------|------------------------|-----|--|
| <b>Status Messages</b> |                        |     |  |
| bbL                    | base block             | 76  | Power modules for motor de-excitation locked   |
| bon                    | close brake            | 85  | Brake control, brake engaged (see chapter 6.9)   |
| boFF                   | open brake             | 86  | Brake control, brake released (see chapter 6.9)  |
| Cdd                    | calculate drive        | 82  | Measurement of the motor stator resistance.  |
| dcb                    | DC brake               | 75  | Motor is decelerated by a DC-voltage at the output.  |
| dLS                    | low speed / DC brake   | 77  | Modulation is switched off after DC-braking (see chapter 6.9 "DC-Braking").  |
| FAcc                   | forward acceleration   | 64  | Acceleration with the adjusted ramps in clockwise direction of rotation.   |
| Fcon                   | forward constant       | 66  | Acceleration / deceleration phase is completed and it is driven with constant speed / frequency in clockwise direction of rotation.                            |
| FdEc                   | forward deceleration   | 65  | It is stopped with the adjusted ramp times in clockwise direction of rotation.   |
| HCL                    | hardware current limit | 80  | The message is output if the output current reaches the hardware current limit.  |
| LAS                    | LA stop                | 72  | This message is displayed if during acceleration the load is limited to the adjusted load level.   |
| LdS                    | Ld stop                | 73  | This message is displayed if during deceleration the load is limited to the adjusted load level or the DC-link current to the adjusted voltage level.          |
| LS                     | low speed              | 70  | No direction of rotation pre-set, modulation is off.   |
| nO_PU                  | power unit not ready   | 13  | Power circuit not ready or not identified by the control.  |
| noP                    | no operation           | 0   | Control release (terminal ST) is not switched.   |
| PA                     | positioning active     | 122 | This message is displayed during a positioning process.  |
| PLS                    | low speed / power off  | 84  | No modulation after Power-Off.   |
| PnA                    | position not reachable | 123 | The specified position cannot be reached within the pre-set ramps. The abort of the positioning can be programmed.   |
| POFF                   | power off function     | 78  | Depending on the programming of the function (see chapter 6.9 „Power-off Function“) the inverter restarts automatically upon system recovery or after a reset. |
| POSI                   | positioning            | 83  | Positioning function active (F5-G).  |
| rAcc                   | reverse acceleration   | 67  | Acceleration with the adjusted ramp times in anti-clockwise direction of rotation.   |
| rcon                   | reverse constant       | 69  | Acceleration / deceleration phase is completed and it is driven with constant speed / frequency in clockwise direction of rotation.                            |
| rdEc                   | reverse deceleration   | 68  | It is stopped with the adjusted ramp times in anti-clockwise direction of rotation.  |
| rFP                    | ready for positioning  | 121 | The drive signals that it is ready to start the positioning process.   |
| SLL                    | stall                  | 71  | This message is displayed if during constant operation the load is limited to the adjusted current limit.  |
| SrA                    | search for ref. active | 81  | Search for reference point approach active.  |
| SSF                    | speed search           | 74  | Speed search function active, that means that the inverter attempts to synchronize onto a running down motor.  |
| STOP                   | quick stop             | 79  | The message is output if as response to a warning signal the quick-stop function becomes active.   |

further on next side

## Error Assistance

| Display               | COMBIVIS                  |    | Meaning   |
|-----------------------|---------------------------|----|---|
| <b>Error Messages</b> |                           |    |   |
| E. br                 | Error! brake              | 56 | Error: can occur in the case of switched on brake control (see chapter 6.9.5), if<br>the load is below the minimum load level (Pn.43) at start up or the absence of an engine phase was detected<br>the load is too high and the hardware current limit is reached  |
| E.buS                 | Error! Watchdog           | 18 | Adjusted monitoring time (Watchdog) of communication between operator and PC / operator and inverter has been exceeded.   |
| E.Cdd                 | Error! calc. drive data   | 60 | Error: During the automatic motor stator resistance measurement.  |
| E.co1                 | Error! counter overrun 1  | 54 | Counter overflow encoder channel 1.   |
| E.co2                 | Error! counter overrun 2  | 55 | Counter overflow encoder channel 2.   |
| E.dOH                 | Error! drive overheat     | 9  | Error: Overtemperature of motor PTC. Error can only be reset at E.ndOH, if PTC is again low-resistance. Causes:<br>resistance at the terminals T1/T2 >1650 Ohm<br>motor overloaded<br>line breakage to the temperature sensor   |
| E.dri                 | Error! driver relay       | 51 | Error: Driver relay. Relay for driver voltage on power circuit has not picked up even though control release was given.   |
| E.EEP                 | Error! EEPROM defective t | 21 | After reset the operation is again possible (without storage in the EEPROM)   |
| E. EF                 | Error! external fault     | 31 | Error: External error. Is triggered, if a digital input is being programmed as external error input and trips.  |
| E.EnC                 | Error! Encoder cable      | 32 | Cable breakage at the resolver or incremental encoder   |
| E.Hyb                 | Error! hybrid             | 52 | Invalid encoder interface identifier.   |
| E.HybC                | Error! hybrid changed     | 59 | Error: Encoder interface identifier has changed, it must be confirmed over ec.0 or ec.10.   |
| E.iEd                 | Error! input error detect | 53 | Hardware failure at the NPN/PNP change-over or at the start/stop measurement.   |
| E.InI                 | Error! initialisation MFC | 57 | MFC not booted.   |
| E.LSF                 | Error! load shunt fault   | 15 | Load-shunt relay has not picked up. occurs for a short time during the switch-on phase, but must automatically be reset immediately. If the error message remains the following causes may be applicable:<br>load-shunt defective<br>input voltage wrong or too low<br>high losses in the supply cable<br>braking resistor wrongly connected or damaged<br>braking module defective |
| E.ndOH                | no ERROR drive overheat   | 11 | Motor temperature switch or PTC at the terminals T1/T2 is again in the normal operating range. The error can be reset now.  |
| E.nOH                 | no E. over heat pow.mod.  | 36 | Temperature of the heat sink is again in the permissible operating range. The error can be reset now.   |
| E.nOHI                | no ERROR overheat int.    | 7  | No longer overheating in the interior E.OHI, interior temperature has fallen by at least 3°C  |
| E.nOL                 | no ERROR overload         | 17 | No more overload, OL-counter has reached 0%; after the error E.OL a cooling phase must elapse. This message appears upon completion of the cooling phase. The error can be reset now. The inverter must remain switched on during the cooling phase.  |
| E.nOL2                | no ERROR overload 2       | 20 | The cooling time has elapsed. The error can be reset.   |

further on next side

| Display | COMBIVIS                    |    | Meaning   |
|---------|-----------------------------|----|---|
| E. OC   | Error! overcurrent          | 4  | Occurs, if the specified peak current is exceeded. Causes:  |
|         |                             |    | acceleration ramps too short  |
|         |                             |    | the load is too big at turned off acceleration stop and turned off constant current limit   |
|         |                             |    | short-circuit at the output   |
|         |                             |    | short-circuit at the output   |
|         |                             |    | deceleration ramp too short   |
|         |                             |    | motor cable too long  |
|         |                             |    | EMC   |
|         |                             |    | DC brake at high ratings active (see 6.9.3)   |
| E. OH   | Error! overheat pow.mod.    | 8  | Error: Overtemperature of power module. Error can only be reset at E.nOH. Causes:   |
|         |                             |    | insufficient air flow at the heat sink (soiled)   |
|         |                             |    | ambient temperature too high  |
|         |                             |    | ventilator clogged  |
| E.OH2   | Error! motor protection     | 30 | Electronic motor protective relay has tripped.  |
| E.OHI   | Error! overheat internal    | 6  | Error: Overheating in the interior: error can only be reset at E.nOHI, if the interior temperature has dropped by at least 3 °C.  |
| E. OL   | Error! overload (lxt)       | 16 | Error: Overload error can only be reset at E.nOL, if OL-counter reaches 0% again. Occurs, if an excessive load is applied longer than for the permissible time (see technical data). Causes:  |
|         |                             |    | poor control adjustment (overshooting)  |
|         |                             |    | mechanical fault or overload in the application   |
|         |                             |    | inverter not correctly dimensioned  |
|         |                             |    | motor wrongly wired motor wrongly wired   |
|         |                             |    | encoder damaged   |
| E.OL2   | Error! overload 2           | 19 | Occurs if the standstill constant current is exceeded (see technical data and overload characteristics). The error can only be reset if the cooling time has elapsed and E.nOL2 is displayed. |
| E. OP   | Error! Overvoltage          | 1  | Voltage in the DC-link circuit too high. Occurs when the DC bus voltage rises above the permissible value. Causes:  |
|         |                             |    | poor controller adjustment (overshooting)   |
|         |                             |    | input voltage too high  |
|         |                             |    | interference voltages at the input  |
|         |                             |    | deceleration ramp too short   |
|         |                             |    | braking resistor defective or too small   |
| E.OS    | Error! over speed           | 58 | Real speed is bigger than the max. output speed.  |
| E.PFC   | Error! Power factor control | 33 | Error in the power factor control   |
| E.PrF   | Error! prot. rot. for.      | 46 | The drive has driven onto the right limit switch. Programmed response „Error, restart after reset“ (see chapter 6.7 „Response to errors or warning messages“).                                |
| E.Prr   | Error! prot. rot. rev.      | 47 | The drive has driven onto the left limit switch. Programmed response „Error, restart after reset“ (see chapter 6.7 „Response to errors or warning messages“).                                 |
| E. Pu   | Error! power unit           | 12 | Error: General power circuit fault  |
| E.Puci  | Error! Unknown power unit   | 49 | Error: During the initialization the power circuit could not be recognized or was identified as invalid.  |
|         |                             |    | further on next side  |

## Error Assistance

| Display                 | COMBIVIS                             |     | Meaning  |
|-------------------------|--------------------------------------|-----|--|
| E.Puch                  | Error! power unit changed            | 50  | Error: Power circuit identification was changed; with a valid power circuit this error can be reset by writing to SY.3. If the value displayed in SY.3 is written, only the power-circuit dependent parameters are reinitialized. If any other value is written, then the default set is loaded. On some systems after writing Sy.3 a Power-On-Reset is necessary.   |
| E.PUCO                  | Error! Power unit communication      | 22  | Error: Parameter value could not be written to the power circuit. Acknowledgement from LT <> OK  |
| E.PUIN                  | Error! Power unit invalid            | 14  | Error: Software version for power circuit and control card are different. Error cannot be reset (only at F5-G B-housing)   |
| E.SbuS                  | Error! bus synchron                  | 23  | Synchronization over sercos-bus not possible. Programmed response „Error, restart after reset“.  |
| E.SET                   | Error! set                           | 39  | It has been attempted to select a locked parameter set. Programmed response „Error, restart after reset“.  |
| E.SLF                   | Error! Software limit switch forward | 44  | The target position lies outside of the limit defined with the right software limit switch. Programmed response „Error, restart after reset“.  |
| E.SLr                   | Error! Software limit switch reverse | 45  | The target position lies outside of the limit defined with the left software limit switch. Programmed response „Error, restart after reset“.   |
| E. UP                   | Error! underpotential                | 2   | Error: Undervoltage (DC-link circuit) Occurs, if DC-link voltage falls below the permissible value. Causes:<br>input voltage too low or instable<br>inverter rating too small<br>voltage losses through wrong cabling<br>the supply voltage through generator / transformer breaks down at very short ramps<br>at F5-G housing B E.UP is also displayed if no communication takes place between power circuit and control card.<br>jump factor (Pn.56) too small<br>if a digital input was programmed as external error input with error message E.UP (Pn.65). |
| E.UPh                   | Error! Phase failure                 | 3   | One phase of the input voltage is missing (ripple-detection)   |
| <b>Warning Messages</b> |                                      |     |  |
| A.buS                   | Warning! Watchdog                    | 93  | Warning: Watchdog for communication between operator/control card or operator/PC has responded. The response to this warning can be programmed.  |
| A.dOH                   | Warning! drive overheat              | 96  | The motor temperature has exceeded an adjustable warning level. The switch off time is started. The response to this warning can be programmed. This warning can be generated only with a special power circuit.   |
| A. EF                   | Warning! external fault              | 90  | This warning is triggered via an external input. The response to this warning can be programmed.   |
| A.ndOH                  | All-clear! drive overheat            | 91  | The motor temperature is again below the adjusted warning level. The switch off time is stopped.   |
| A.nOH                   | All-clear! overheat pow.mod.         | 88  | The heat sink temperature is again below the adjusted warning level.   |
| A.nOHI                  | All-clear! overheat internal         | 92  | The temperature in the interior of the inverter is again below the warning threshold.  |
| A.nOL                   | All-clear! overload                  | 98  | OL counter has reached 0 %, the warning "overload" can be reset.   |
| A.nOL2                  | All-clear! overload 2                | 101 | The cooling time after "Warning! Overload during standstill" has elapsed. The warning message can be reset.  |
| A. OH                   | Warning! overheat pow.mod.           | 89  | A level can be defined, when it is exceeded this warning is output. The response to this warning can be programmed.  |

further on next side

| Display | COMBIVIS                               |     | Meaning   |
|---------|--|-----|---|
| A.OH2   | Warning! motor protection              | 97  | Warning: electronic motor protective relay has tripped. The response to this warning can be programmed.   |
| A.OHI   | Warning! overheat internal             | 87  | The temperature in the interior of the inverter lies above the permissible level. The switch off time was started. The programmed response to this warning message is executed.   |
| A.OL    | Warning! overload                      | 99  | A level between 0 and 100 % of the load counter can be adjusted, when it is exceeded this warning is output. The response to this warning can be programmed.  |
| A.OL2   | Warning! overload 2                    | 100 | The warning is output when the standstill continuous current is exceeded (see technical data and overload characteristics). The response to this warning can be programmed. The warning message can only be reset after the cooling time has elapsed and A.nOL2 is displayed. |
| A.PrF   | Warning! prot. rot. for.               | 94  | The drive has driven onto the right limit switch. The response to this warning can be programmed.   |
| A.Prr   | Warning! prot. rot. rev.               | 95  | The drive has driven onto the left limit switch. The response to this warning can be programmed.  |
| A.SbuS  | Warning! synchron                      | 103 | Synchronization over sercos-bus not possible. The response to this warning can be programmed.   |
| A.SET   | Warning! set                           | 102 | It has been attempted to select a locked parameter set. The response to this warning can be programmed.   |
| A.SLF   | Warning! Software limit switch forward | 104 | The target position lies outside of the limit defined with the right software limit switch. The response to this warning can be programmed.   |
| A.SLr   | Warning! Software limit switch reverse | 105 | The target position lies outside of the limit defined with the left software limit switch. The response to this warning can be programmed.  |



## 5. Initial Start-up

For the initial start-up of KEB COMBIVERT F5-M do the following:

- |  |    |                                    |
|--|----|------------------------------------|
| 1. Open control release (terminal X2A.16). | => | frequency inverter in status „noP“ |
| 2. Select open loop operation              | => | Parameter CP.10 = 0                |
| 3. Enter motor data                        | => | Parameter CP.11...CP.16            |
| 4. Activate load motor dependent parameter | => | Parameter CP.17 = 1 or 2           |
| 5. Enter necessary boost                   | => | Parameter CP.18                    |
| 6. Enter encoder line number               | => | Parameter CP.20                    |
| 7. Observe cut-off frequency of encoder    | => | See encoder specification          |
| 8. Startup in controlled operation         | => | See the following flow chart       |

GB

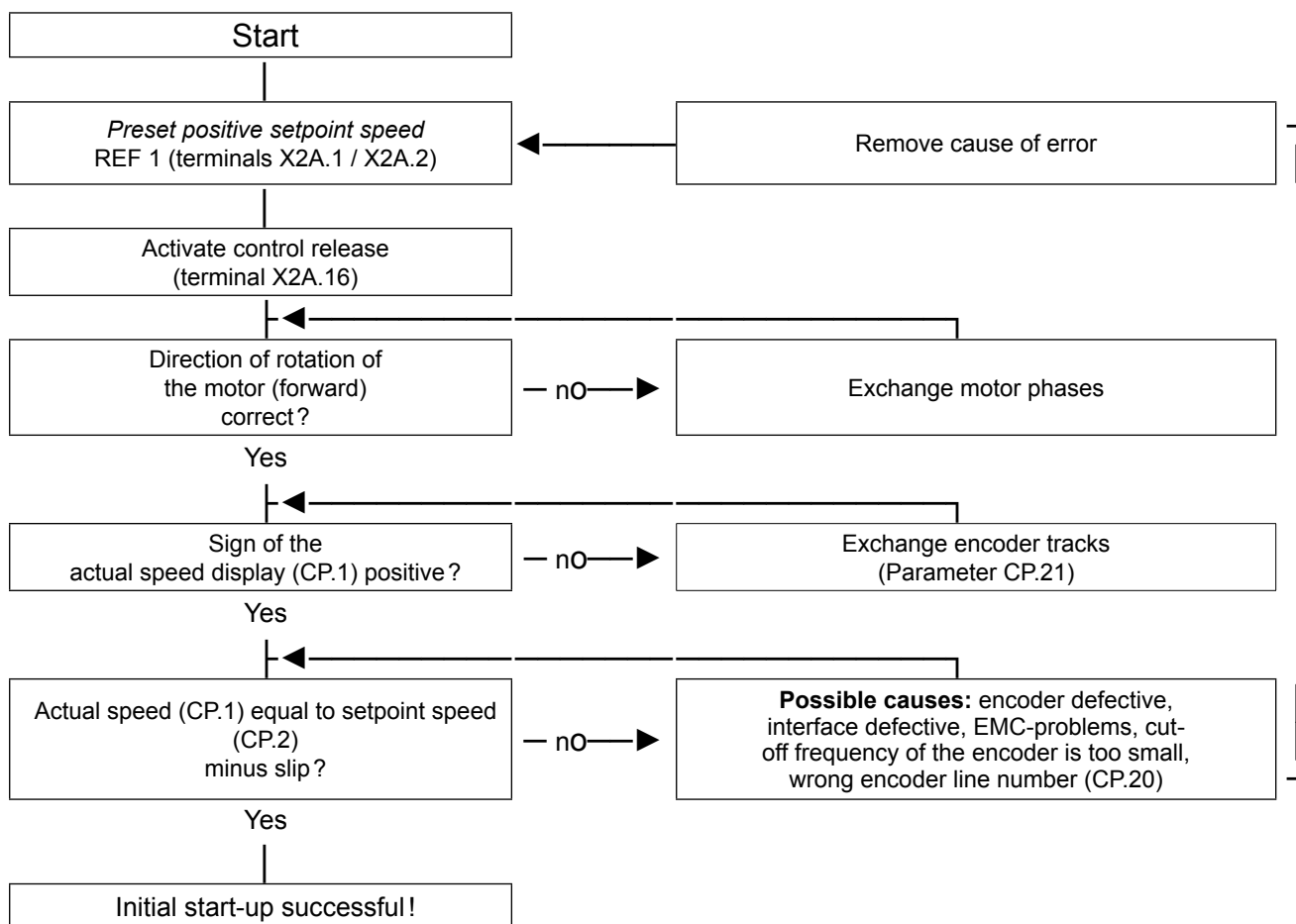

6. Adjustment Speed Controller

1. Open control release (terminal X2A.16).
2. Select closed loop operation

- => frequency inverter in status „noP“
- => Parameter CP.10 = 4

GB

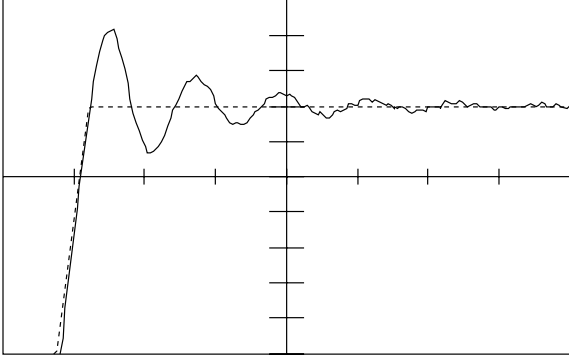
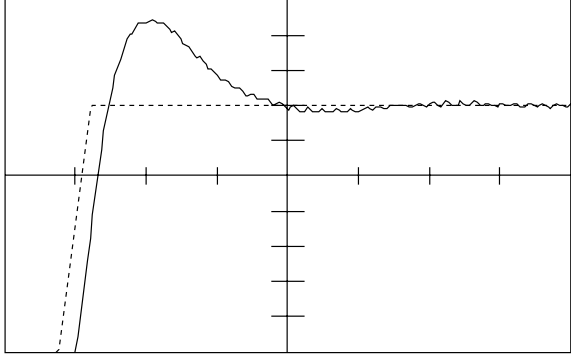
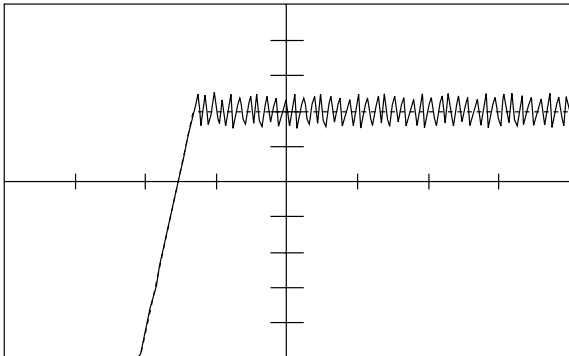
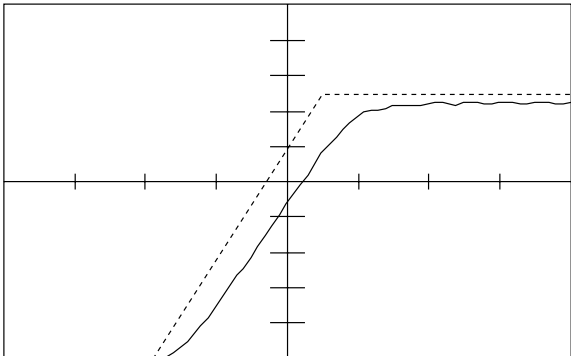
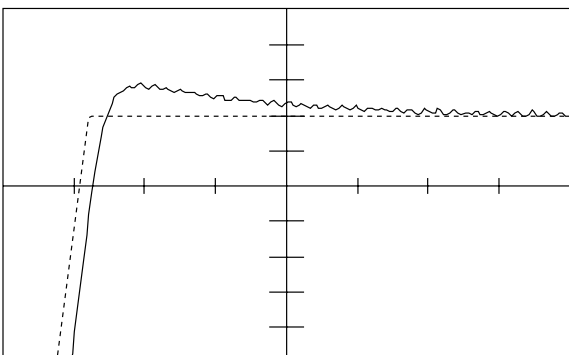
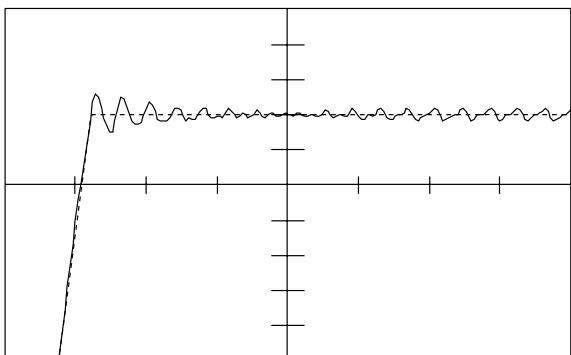
|   |   |  |   |
|---|---|--|---|
|    |   |    |   |
| <b>Problem</b>  | Very long transient process                                   | <b>Problem</b>   | Very long speed overshoot                                     |
| <b>Solution</b>   | Increase KP speed (CP.30); eventually reduce KI speed (CP.31) | <b>Solution</b>  | Increase KP speed (CP.30); eventually reduce KI speed (CP.31) |
|   |   |   |   |
| <b>Problem</b>  | Sustained oscillation short billowy, noises, vibes            | <b>Problem</b>   | Transient too slow / remaining system deviation               |
| <b>Solution</b>   | Decrease KP speed (CP.30)                                     | <b>Solution</b>  | Increase KI speed (CP.31)                                     |
|  |   |  |   |
| <b>Problem</b>  | Overshoot too long, strong speed decreases at load change     | <b>Problem</b>   | Sustained oscillation long billowy                            |
| <b>Solution</b>   | Increase KI speed (CP.31)                                     | <b>Solution</b>  | Reduce KI speed (CP.31) and / or reduce KP speed (CP.30)      |



## 7. Quick Reference

| Parameter |                                | Setting range       | Resolution | ↵ | Customer setting |
|-----------|--------------------------------|---------------------|------------|---|------------------|
| CP.00     | Password Input                 | 0...9999            | 1          |   | —                |
| CP.01     | Encoder 1 speed                | —                   | 0.125 rpm  |   | —                |
| CP.02     | Setpoint display               | —                   | 0.125 rpm  |   | —                |
| CP.03     | Inverter state                 | —                   | 1          |   | —                |
| CP.04     | Apparent current               | —                   | 0.1 A      |   | —                |
| CP.05     | Peak apparent current          | —                   | 0.1 A      |   | —                |
| CP.06     | Actual torque                  | —                   | 0,01 Nm    |   | —                |
| CP.07     | Actual DC voltage              | —                   | 1 V        |   | —                |
| CP.08     | Peak DC voltage                | —                   | 1 V        |   | —                |
| CP.09     | Output voltage                 | —                   | 1 V        |   | —                |
| CP.10     | Speed control configuration    | 0 (off)...5         | 1          |   |                  |
| CP.11     | DASM Rated speed               | 0...64000 rpm       | 1 rpm      |   |                  |
| CP.12     | DASM rated frequency           | 0.0...1600.0 Hz     | 0.1 Hz     |   |                  |
| CP.13     | DASM rated current             | 0.0...710.0 A       | 0.1 A      |   |                  |
| CP.14     | DASM Rated voltage             | 120...500 V         | 1 V        |   |                  |
| CP.15     | DASM Rated cos (phi)           | 0.50...1.00         | 0.01       |   |                  |
| CP.16     | DASM Rated power               | 0.35...400.00 kW    | 0.01 kW    |   |                  |
| CP.17     | Load motor dependent parameter | 0...2               | 1          |   |                  |
| CP.18     | Boost                          | 0.0...25.5 %        | 0.1 %      |   |                  |
| CP.19     | rated frequency                | 0...400 Hz          | 0.0125 Hz  |   |                  |
| CP.20     | Encoder 1 (inc/r)              | 1...16383 inc.      | 1 inc.     |   |                  |
| CP.21     | Encoder 1 rotation             | 0...19              | 1          | x |                  |
| CP.22     | Maximum speed                  | 0...4000 rpm        | 0.125 rpm  |   |                  |
| CP.23     | Step value 1                   | +4000 rpm           | 0.125 rpm  |   |                  |
| CP.24     | Step value 2                   | +4000 rpm           | 0.125 rpm  |   |                  |
| CP.25     | Acceleration time              | 0.00...300.00 s     | 0.01 s     |   |                  |
| CP.26     | Deceleration time              | -0.01...300.00 s    | 0.01 s     |   |                  |
| CP.27     | S-curve time                   | 0.00 (off)...5.00 s | 0.01 s     |   |                  |
| CP.28     | Torque reference source        | 0...5               | 1          | x |                  |
| CP.29     | Absolute torque reference      | +10000.00 Nm        | 0,01 Nm    |   |                  |
| CP.30     | KP speed                       | 0...32767           | 1          |   |                  |
| CP.31     | KI speed                       | 0...32767           | 1          |   |                  |
| CP.32     | Switching frequency            | 2/4/8/12/16 kHz     | —          | x |                  |
| CP.33     | Relay output 1 / Function      | 0...84              | 1          | x |                  |
| CP.34     | Relay output 2 / Function      | 0...84              | 1          | x |                  |
| CP.35     | Reaction to limit switch       | 0...6               | 1          |   |                  |
| CP.36     | Reaction to external fault     | 0...6               | 1          |   |                  |

GB

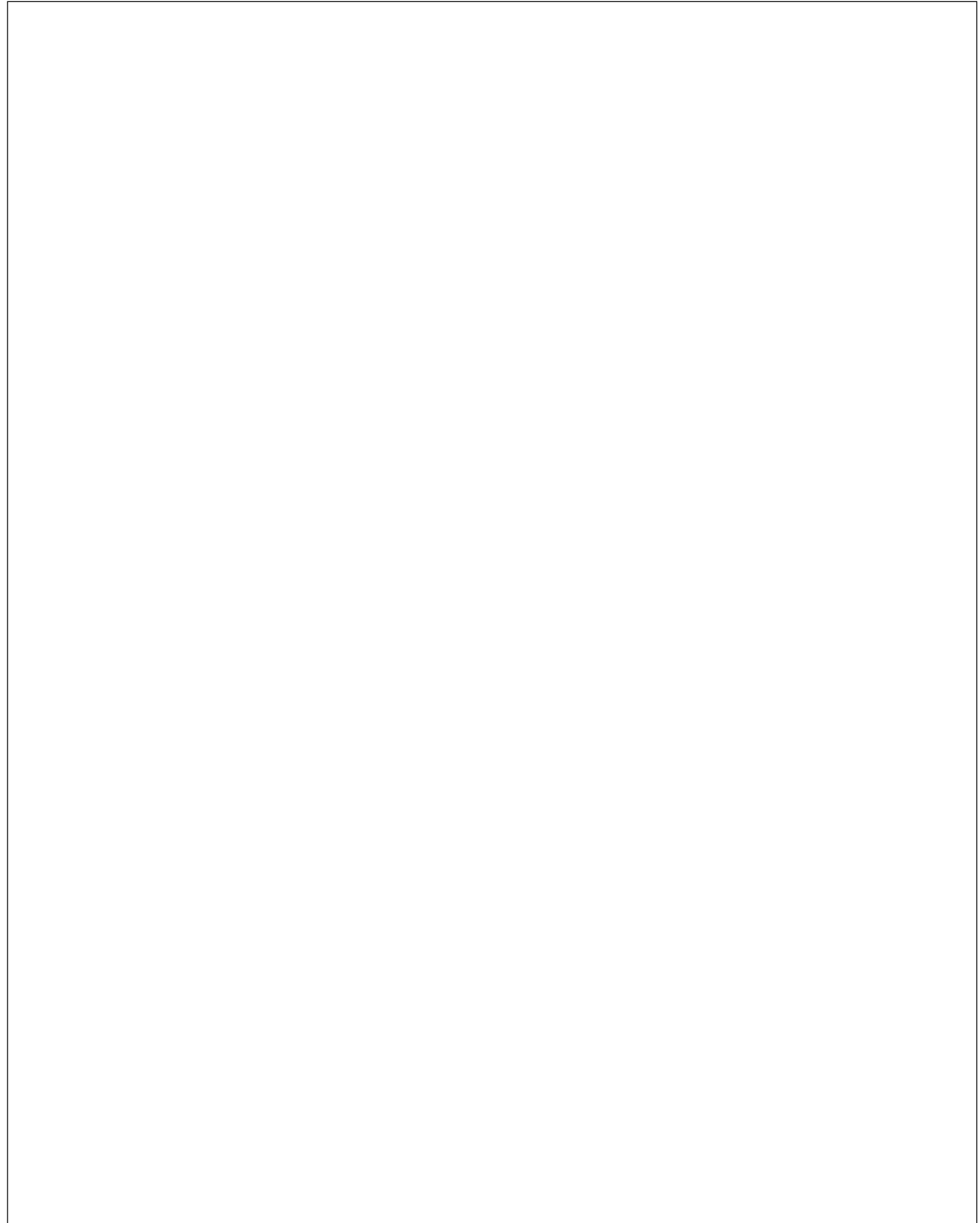

## Passwords

---

### 8. Passwords

| Read only |  | Read/Write |  | Drive mode |
|-----------|--|------------|--|------------|
| 100       |  | 200        |  | 500        |



**Karl E. Brinkmann GmbH**  
Försterweg 36-38 • D-32683 Barntrup  
fon: +49 5263 401-0 • fax: +49 5263 401-116  
net: [www.keb.de](http://www.keb.de) • mail: [info@keb.de](mailto:info@keb.de)

**KEB Antriebstechnik GmbH & Co. KG**  
Wildbacher Str. 5 • D-08289 Schneeberg  
fon: +49 3772 67-0 • fax: +49 3772 67-281  
mail: [info@keb-combidrive.de](mailto:info@keb-combidrive.de)

**KEB Antriebstechnik Austria GmbH**  
Ritzstraße 8 • A-4614 Marchtrenk  
fon: +43 7243 53586-0 • fax: +43 7243 53586-21  
net: [www.keb.at](http://www.keb.at) • mail: [info@keb.at](mailto:info@keb.at)

**KEB Antriebstechnik**  
Herenveld 2 • B-9500 Geraadsbergen  
fon: +32 5443 7860 • fax: +32 5443 7898  
mail: [vb.belgien@keb.de](mailto:vb.belgien@keb.de)

**KEB Power Transmission Technology (Shanghai) Co. Ltd – Office Room 401**  
No. 665 North Songwei Road (New Husong Road),  
Songjiang District, CHN-201613 Shanghai, P.R. China  
fon: +86 21 51095995 • fax: +86 21 54450115  
net: [www.keb.cn](http://www.keb.cn) • mail: [info@keb.cn](mailto:info@keb.cn)

**KEB Antriebstechnik Austria GmbH**  
Organizační složka  
K. Weise 1675/5 • CZ-370 04 České Budějovice  
fon: +420 387 699 111 • fax: +420 387 699 119  
net: [www.keb.cz](http://www.keb.cz) • mail: [info.keb@seznam.cz](mailto:info.keb@seznam.cz)

**KEB España**  
C/ Mitjer, Nave 8 - Pol. Ind. LA MASIA  
E-08798 Sant Cugat Sesgarrigues (Barcelona)  
fon: +34 93 897 0268 • fax: +34 93 899 2035  
mail: [vb.espana@keb.de](mailto:vb.espana@keb.de)

**Société Française KEB**  
Z.I. de la Croix St. Nicolas • 14, rue Gustave Eiffel  
F-94510 LA QUEUE EN BRIE  
fon: +33 1 49620101 • fax: +33 1 45767495  
net: [www.keb.fr](http://www.keb.fr) • mail: [info@keb.fr](mailto:info@keb.fr)

**KEB (UK) Ltd.**  
6 Chieftain Business Park, Morris Close  
Park Farm, Wellingborough GB-Northants, NN8 6 XF  
fon: +44 1933 402220 • fax: +44 1933 400724  
net: [www.keb-uk.co.uk](http://www.keb-uk.co.uk) • mail: [info@keb-uk.co.uk](mailto:info@keb-uk.co.uk)

**KEB Italia S.r.l.**  
Via Newton, 2 • I-20019 Settimo Milanese (Milano)  
fon: +39 02 33535311 • fax: +39 02 33500790  
net: [www.keb.it](http://www.keb.it) • mail: [kebitalia@keb.it](mailto:kebitalia@keb.it)

**KEB Japan Ltd.**  
15-16, 2-Chome, Takanawa Minato-ku  
J-Tokyo 108-0074  
fon: +81 33 445-8515 • fax: +81 33 445-8215  
mail: [info@keb.jp](mailto:info@keb.jp)

**KEB Korea Seoul**  
Room 1709, 415 Missy 2000  
725 Su Seo Dong, Gang Nam Gu  
ROK-135-757 Seoul/South Korea  
fon: +82 2 6253 6771 • fax: +82 2 6253 6770  
mail: [vb.korea@keb.de](mailto:vb.korea@keb.de)

**KEB RUS Ltd.**  
Dolgorukovskaja str. 33, building 8  
RUS-127006 Moscow  
fon: +007 499 972 3162 • fax: +007 499 978 9573  
mail: [info@keb.ru](mailto:info@keb.ru)

**KEB Sverige**  
Box 265 (Bergavägen 19)  
S-43093 Hälsö  
fon: +46 31 961520 • fax: +46 31 961124  
mail: [vb.schweden@keb.de](mailto:vb.schweden@keb.de)

**KEB America, Inc.**  
5100 Valley Industrial Blvd. South  
USA-Shakopee, MN 55379  
fon: +1 952 224-1400 • fax: +1 952 224-1499  
net: [www.kebamerica.com](http://www.kebamerica.com) • mail: [info@kebamerica.com](mailto:info@kebamerica.com)